

PART DESCRIPTION : EXP. KIT WALL MOUNTED BASIN TAP

CAT NO. F380022CP

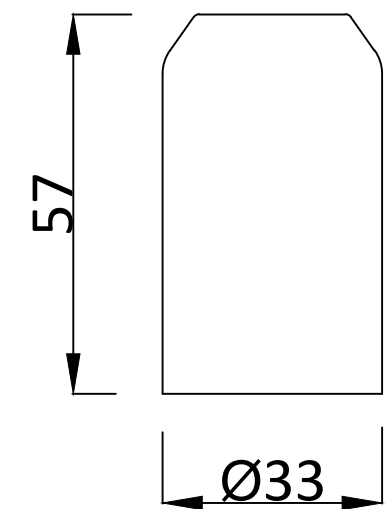
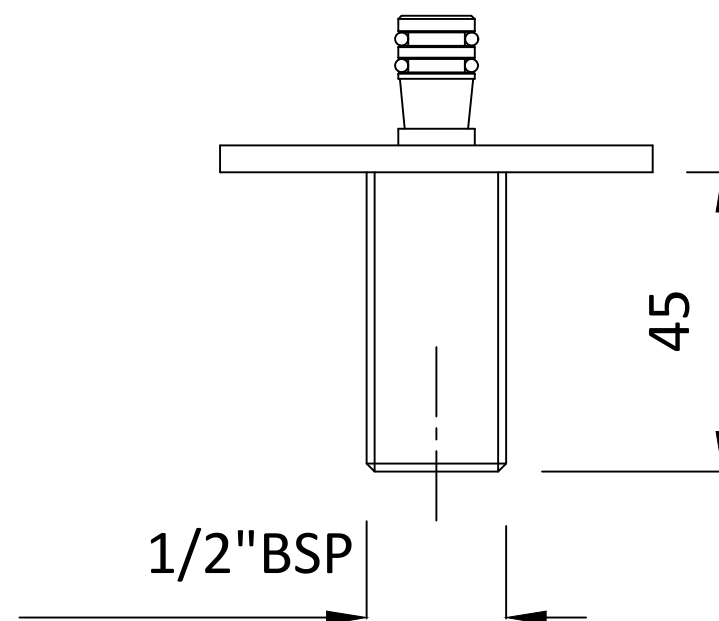
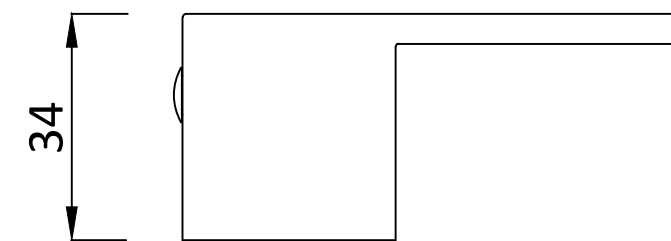
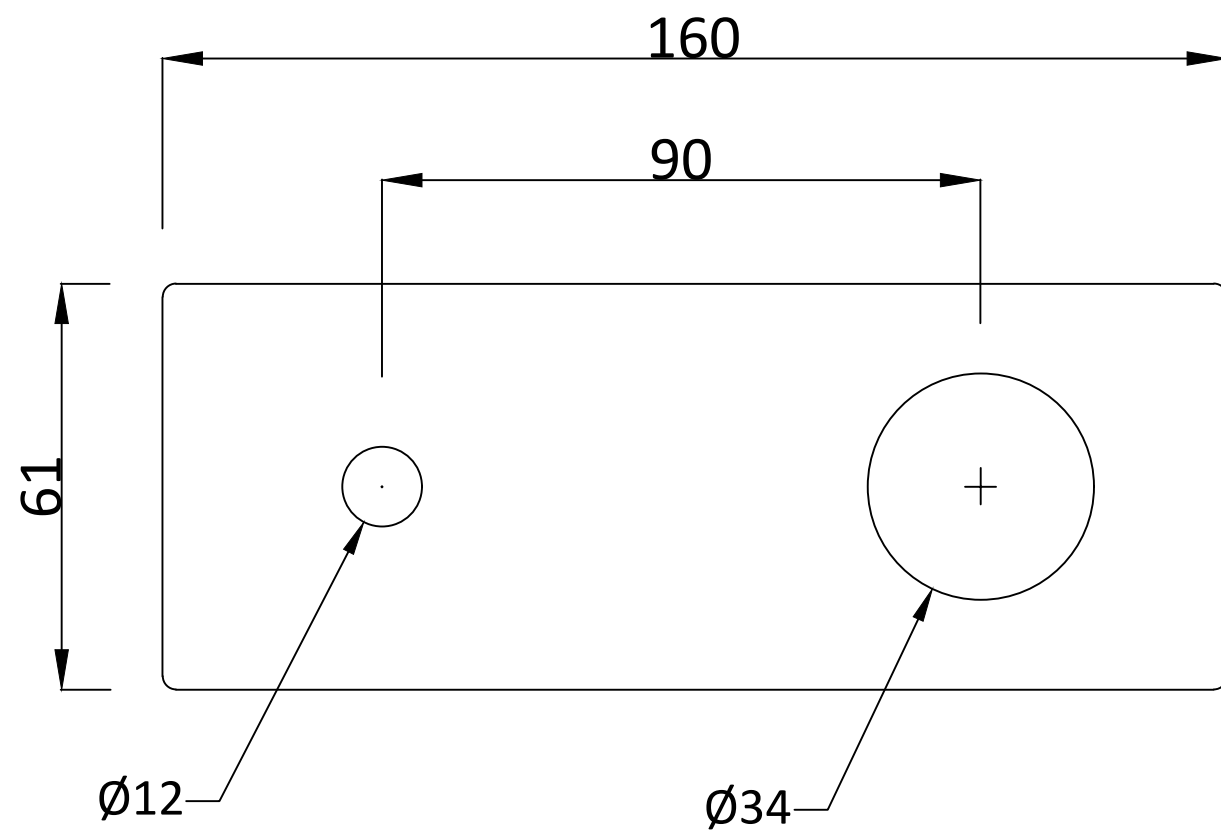
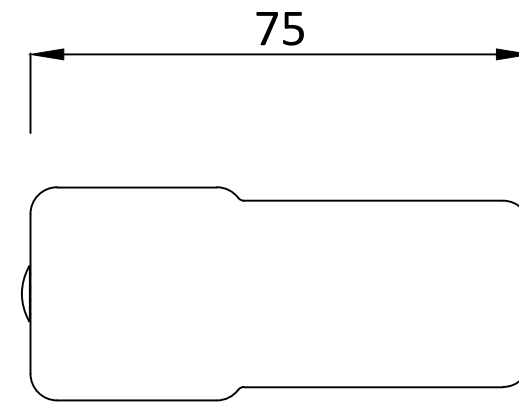
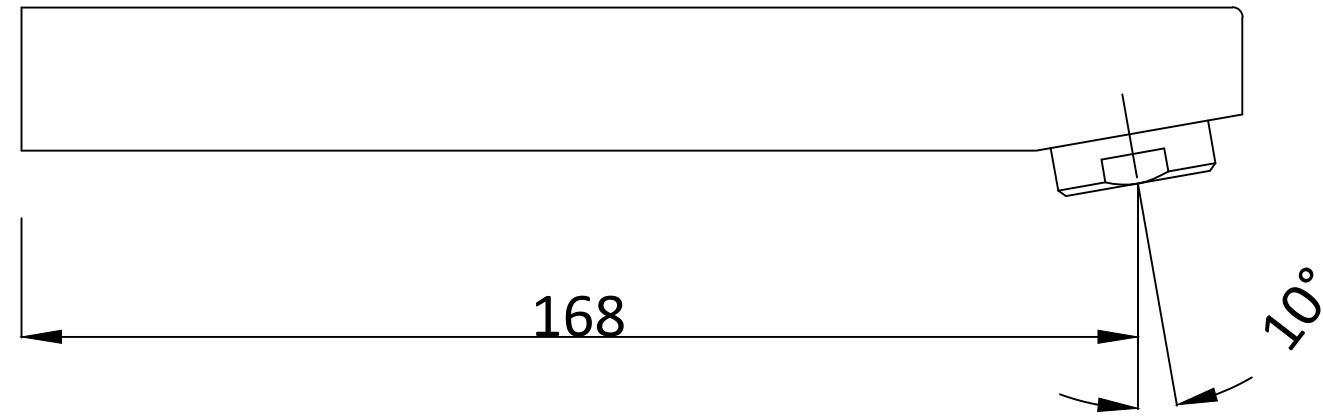

RSC